



STP3NK90Z - STP3NK90ZFP STD3NK90Z - STD3NK90Z-1

N-CHANNEL 900V - 4.1Ω - 3A TO-220/TO-220FP/DPAK/IPAK
Zener-Protected SuperMESH™ Power MOSFET

| TYPE | V _{DSS} | R _{DS(on)} | I _D | P _w |
|-------------|------------------|---------------------|----------------|----------------|
| STP3NK90Z | 900 V | < 4.8 Ω | 3 A | 90 W |
| STP3NK90ZFP | 900 V | < 4.8 Ω | 3 A | 25 W |
| STD3NK90Z | 900 V | < 4.8 Ω | 3 A | 90 W |
| STD3NK90Z-1 | 900 V | < 4.8 Ω | 3 A | 90 W |

- TYPICAL R_{DS(on)} = 4.1 Ω
- EXTREMELY HIGH dv/dt CAPABILITY
- 100% AVALANCHE TESTED
- GATE CHARGE MINIMIZED
- VERY LOW INTRINSIC CAPACITANCES
- VERY GOOD MANUFACTURING REPEATABILITY



DESCRIPTION

The SuperMESH™ series is obtained through an extreme optimization of ST's well established strip-based PowerMESH™ layout. In addition to pushing on-resistance significantly down, special care is taken to ensure a very good dv/dt capability for the most demanding applications. Such series complements ST full range of high voltage MOSFETs including revolutionary MDmesh™ products.

APPLICATIONS

- HIGH CURRENT, HIGH SPEED SWITCHING
- IDEAL FOR OFF-LINE POWER SUPPLIES, ADAPTORS AND PFC
- LIGHTING

INTERNAL SCHEMATIC DIAGRAM



ORDERING INFORMATION

| SALES TYPE | MARKING | PACKAGE | PACKAGING |
|-------------|-----------|----------|-------------|
| STP3NK90Z | P3NK90Z | TO-220 | TUBE |
| STP3NK90ZFP | P3NK90ZFP | TO-220FP | TUBE |
| STD3NK90ZT4 | D3NK90Z | DPAK | TAPE & REEL |
| STD3NK90Z-1 | D3NK90Z | IPAK | TUBE |

STP3NK90Z - STP3NK90ZFP - STD3NK90Z - STD3NK90Z-1

ABSOLUTE MAXIMUM RATINGS

| Symbol | Parameter | Value | | | Unit |
|------------------------------------|---|------------|-------------|--------------------------|------|
| | | STP3NK90Z | STP3NK90ZFP | STD3NK90Z STD3NK90Z-1 | |
| V _{DS} | Drain-source Voltage (V _{GS} = 0) | 900 | | | V |
| V _{DGR} | Drain-gate Voltage (R _{GS} = 20 kΩ) | 900 | | | V |
| V _{GS} | Gate- source Voltage | ± 30 | | | V |
| I _D | Drain Current (continuous) at T _C = 25°C | 3 | 3 (*) | 3 | A |
| I _D | Drain Current (continuous) at T _C = 100°C | 1.89 | 1.89 (*) | 1.89 | A |
| I _{DM} (•) | Drain Current (pulsed) | 12 | 12 (*) | 12 | A |
| P _{TOT} | Total Dissipation at T _C = 25°C | 90 | 25 | 90 | W |
| | Derating Factor | 0.72 | 0.2 | 0.72 | W/°C |
| V _{ESD(G-S)} | Gate source ESD(HBM-C=100pF, R=1.5KΩ) | 4000 | | | V |
| dv/dt (1) | Peak Diode Recovery voltage slope | 4.5 | | | V/ns |
| V _{ISO} | Insulation Withstand Voltage (DC) | - | 2500 | - | V |
| T _j T _{stg} | Operating Junction Temperature Storage Temperature | -55 to 150 | | | °C |

(•) Pulse width limited by safe operating area

(1) I_{SD} ≤ 3A, di/dt ≤ 200A/μs, V_{DD} ≤ V(BR)DSS, T_j ≤ T_{JMAX}.

(*) Limited only by maximum temperature allowed

THERMAL DATA

| | | TO-220 | TO-220FP | DPAK IPAK | |
|-----------------------|--|--------|----------|--------------|------|
| R _{thj-case} | Thermal Resistance Junction-case Max | 1.38 | 5 | 1.38 | °C/W |
| R _{thj-amb} | Thermal Resistance Junction-ambient Max | 62.5 | | 100 | °C/W |
| T _l | Maximum Lead Temperature For Soldering Purpose | 300 | | | °C |

AVALANCHE CHARACTERISTICS

| Symbol | Parameter | Max Value | Unit |
|-----------------|---|-----------|------|
| I _{AR} | Avalanche Current, Repetitive or Not-Repetitive (pulse width limited by T _j max) | 3 | A |
| E _{AS} | Single Pulse Avalanche Energy (starting T _j = 25 °C, I _D = I _{AR} , V _{DD} = 50 V) | 180 | mJ |

GATE-SOURCE ZENER DIODE

| Symbol | Parameter | Test Conditions | Min. | Typ. | Max. | Unit |
|-------------------|-------------------------------|--------------------------------------|------|------|------|------|
| BV _{GSO} | Gate-Source Breakdown Voltage | I _{gs} = ± 1mA (Open Drain) | 30 | | | V |

PROTECTION FEATURES OF GATE-TO-SOURCE ZENER DIODES

The built-in back-to-back Zener diodes have specifically been designed to enhance not only the device's ESD capability, but also to make them safely absorb possible voltage transients that may occasionally be applied from gate to source. In this respect the Zener voltage is appropriate to achieve an efficient and cost-effective intervention to protect the device's integrity. These integrated Zener diodes thus avoid the usage of external components.

STP3NK90Z - STP3NK90ZFP - STD3NK90Z - STD3NK90Z-1

ELECTRICAL CHARACTERISTICS (T_{CASE} = 25°C UNLESS OTHERWISE SPECIFIED) ON/OFF

| Symbol | Parameter | Test Conditions | Min. | Typ. | Max. | Unit |
|----------------------|---|---|------|------|---------|----------|
| V _{(BR)DSS} | Drain-source Breakdown Voltage | I _D = 1 mA, V _{GS} = 0 | 900 | | | V |
| I _{DSS} | Zero Gate Voltage Drain Current (V _{GS} = 0) | V _{DS} = Max Rating V _{DS} = Max Rating, T _C = 125 °C | | | 1 50 | μA μA |
| I _{GSS} | Gate-body Leakage Current (V _{DS} = 0) | V _{GS} = ± 30 V | | | ±10 | μA |
| V _{GS(th)} | Gate Threshold Voltage | V _{DS} = V _{GS} , I _D = 50 μA | 3 | 3.75 | 4.5 | V |
| R _{DSON} | Static Drain-source On Resistance | V _{GS} = 10 V, I _D = 1.5 A | | 4.1 | 4.8 | Ω |

DYNAMIC

| Symbol | Parameter | Test Conditions | Min. | Typ. | Max. | Unit |
|--|---|--|------|-----------------|------|----------------|
| g _{fs} (1) | Forward Transconductance | V _{DS} = 15 V, I _D = 1.5 A | | 2.7 | | S |
| C _{iss} C _{oss} C _{rss} | Input Capacitance Output Capacitance Reverse Transfer Capacitance | V _{DS} = 25 V, f = 1 MHz, V _{GS} = 0 | | 590 63 13 | | pF pF pF |
| C _{oss eq.} (3) | Equivalent Output Capacitance | V _{GS} = 0 V, V _{DS} = 0 V to 400V | | 34 | | pF |

SWITCHING ON

| Symbol | Parameter | Test Conditions | Min. | Typ. | Max. | Unit |
|--|--|---|------|-------------------|------|----------------|
| t _{d(on)} t _r | Turn-on Delay Time Rise Time | V _{DD} = 450 V, I _D = 1.5 A R _G = 4.7Ω V _{GS} = 10 V (Resistive Load see, Figure 3) | | 18 7 | | ns ns |
| Q _g Q _{gs} Q _{gd} | Total Gate Charge Gate-Source Charge Gate-Drain Charge | V _{DD} = 720V, I _D = 3 A, V _{GS} = 10V | | 22.7 4.2 12 | | nC nC nC |

SWITCHING OFF

| Symbol | Parameter | Test Conditions | Min. | Typ. | Max. | Unit |
|--|---|---|------|------------------|------|----------------|
| t _{d(off)} t _f | Turn-off Delay Time Fall Time | V _{DD} = 720 V, I _D = 1.5 A R _G = 4.7Ω V _{GS} = 10 V (Resistive Load see, Figure 3) | | 45 18 | | ns ns |
| t _{r(Voff)} t _f t _c | Off-voltage Rise Time Fall Time Cross-over Time | V _{DD} = 450V, I _D = 3 A, R _G = 4.7Ω, V _{GS} = 10V (Inductive Load see, Figure 5) | | 14.5 15 16 | | ns ns ns |

SOURCE DRAIN DIODE

| Symbol | Parameter | Test Conditions | Min. | Typ. | Max. | Unit |
|--|--|--|------|-------------------|---------|---------------|
| I _{SD} I _{SDM} (2) | Source-drain Current Source-drain Current (pulsed) | | | | 3 12 | A A |
| V _{SD} (1) | Forward On Voltage | I _{SD} = 3 A, V _{GS} = 0 | | | 1.6 | V |
| t _{rr} Q _{rr} I _{RRM} | Reverse Recovery Time Reverse Recovery Charge Reverse Recovery Current | I _{SD} = 3 A, di/dt = 100A/μs V _{DD} = 100V, T _J = 150°C (see test circuit, Figure 5) | | 510 2.2 8.7 | | ns μC A |

Note: 1. Pulsed: Pulse duration = 300 μs, duty cycle 1.5 %.

2. Pulse width limited by safe operating area.

3. C_{oss eq.} is defined as a constant equivalent capacitance giving the same charging time as C_{oss} when V_{DS} increases from 0 to 80% V_{DSS}.

Safe Operating Area For TO-220/DPAK/IPAK

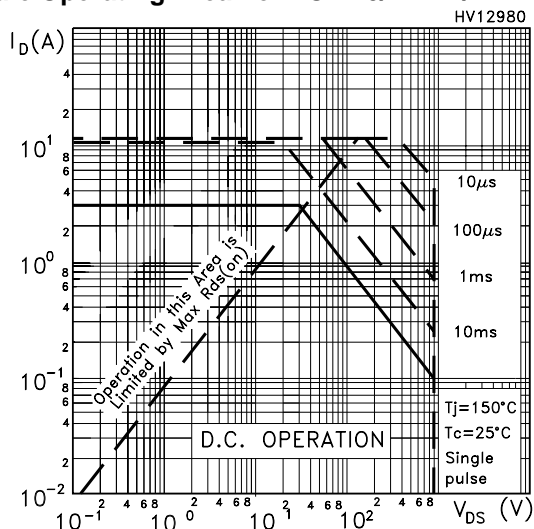

Safe Operating Area For TO-220FP

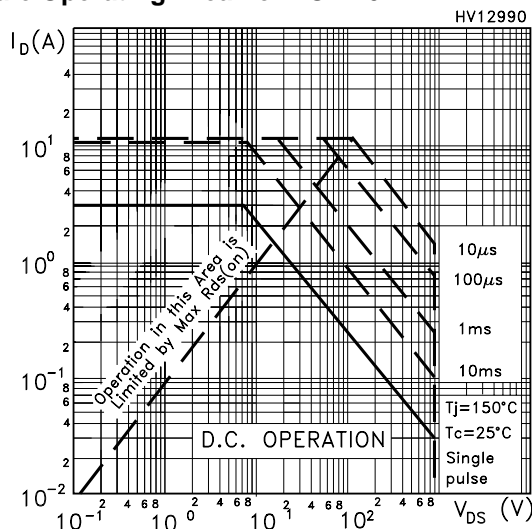

Thermal Impedance For TO-220/DPAK/IPAK

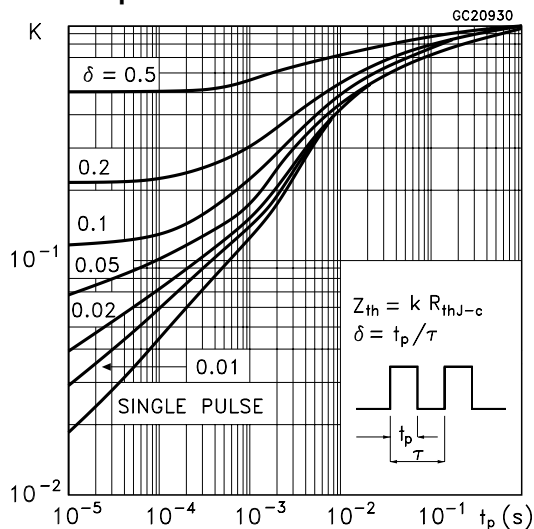

Thermal Impedance For TO-220FP

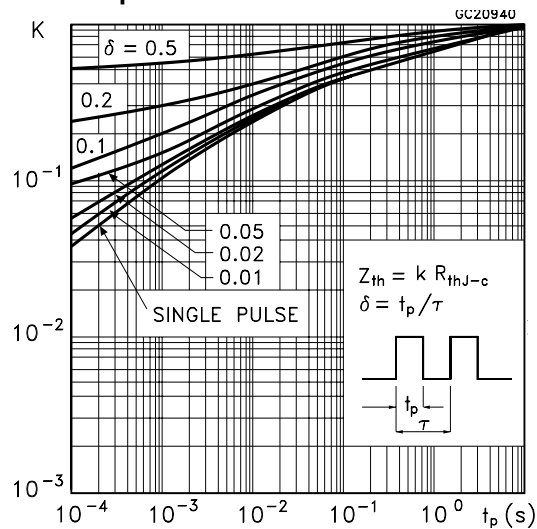

Output Characteristics

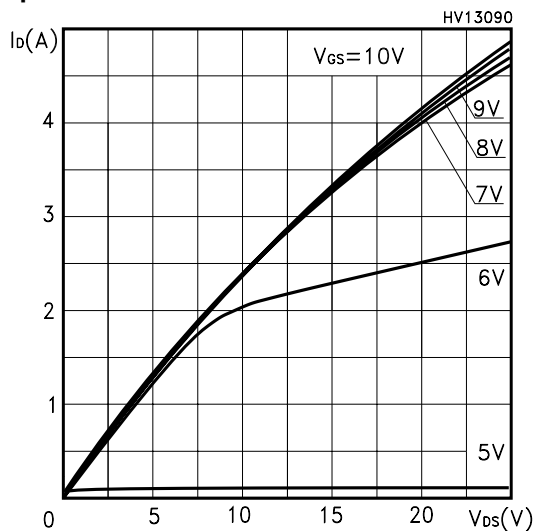

Transfer Characteristics

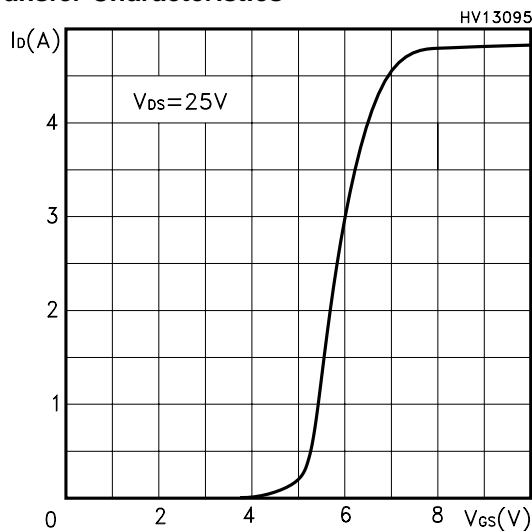

Transconductance

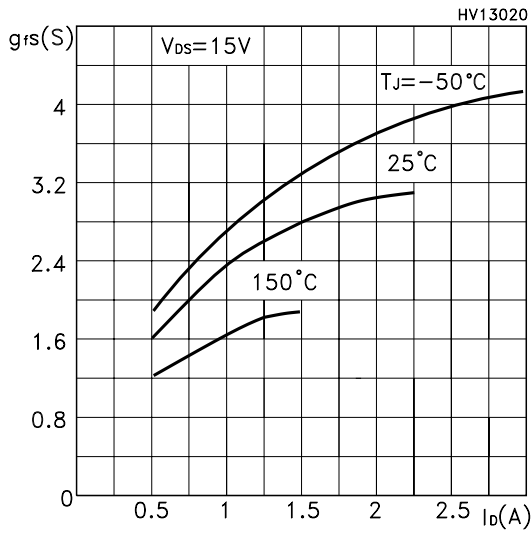

Static Drain-source On Resistance

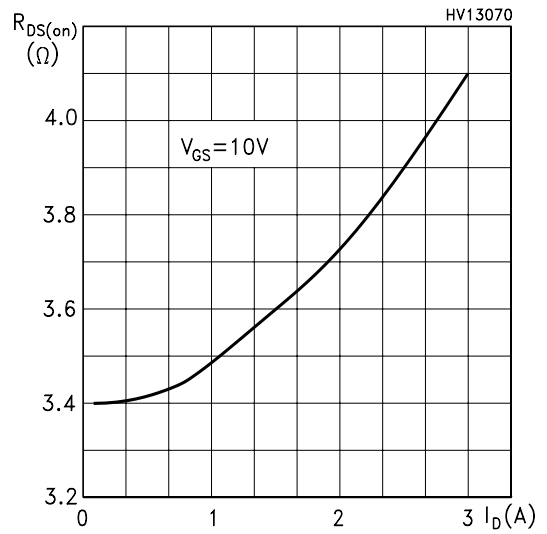

Gate Charge vs Gate-source Voltage

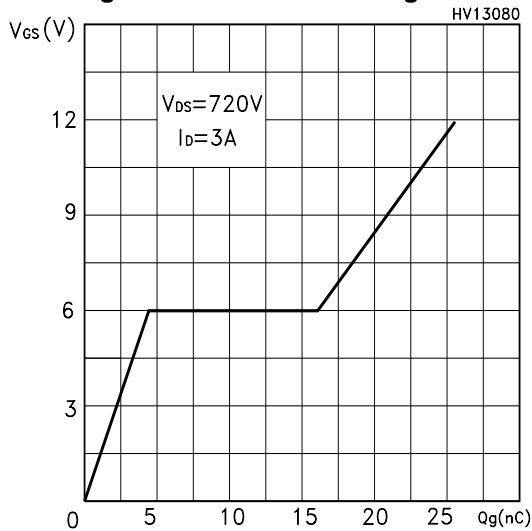

Capacitance Variations

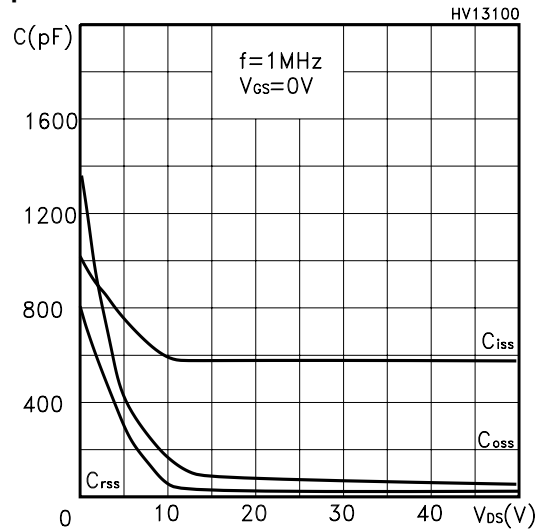

Normalized Gate Threshold Voltage vs Temp.

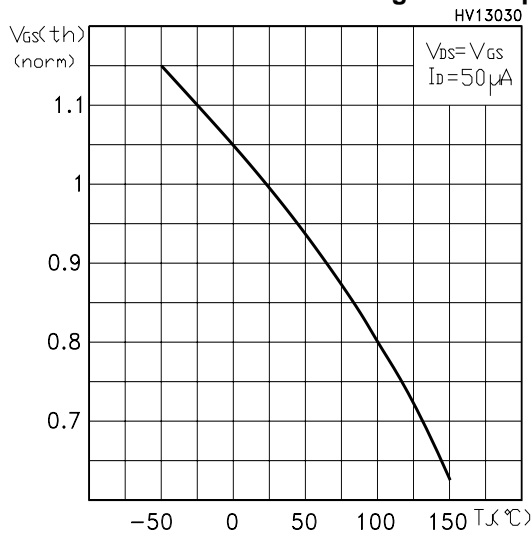

Normalized On Resistance vs Temperature

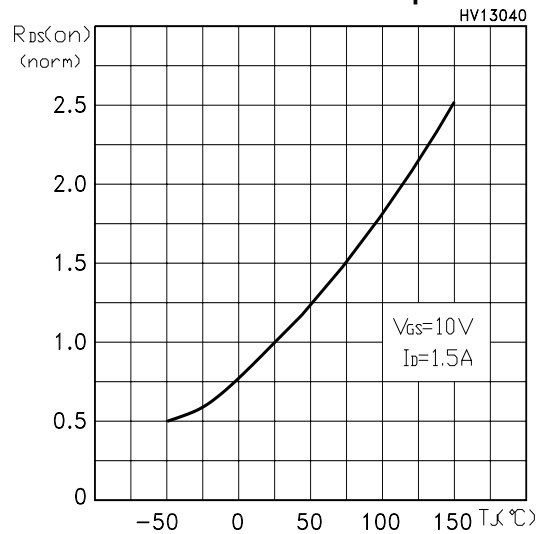

Source-drain Diode Forward Characteristics

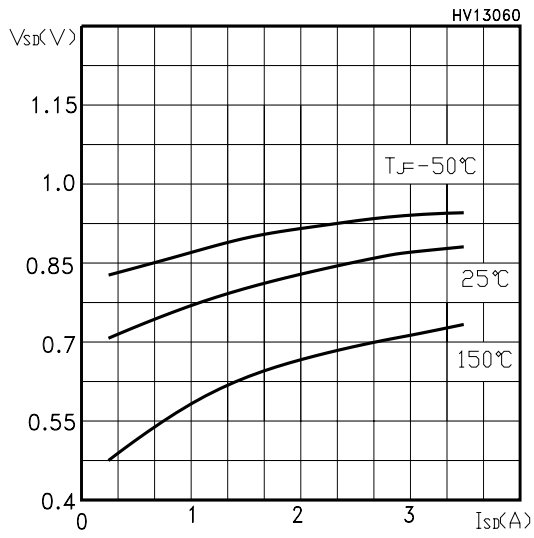

Normalized BVDSS vs Temperature

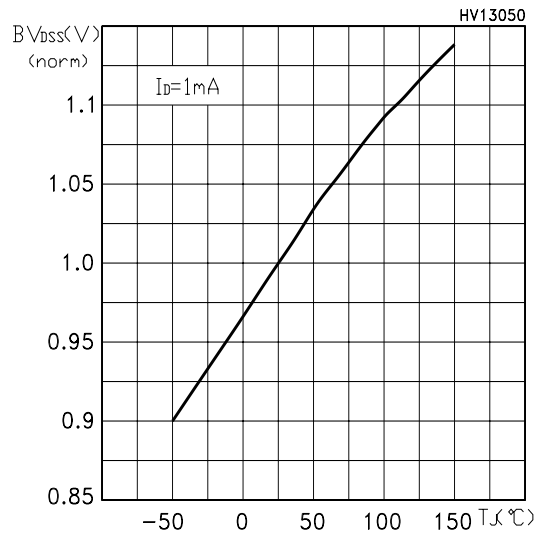

Maximum Avalanche Energy vs Temperature

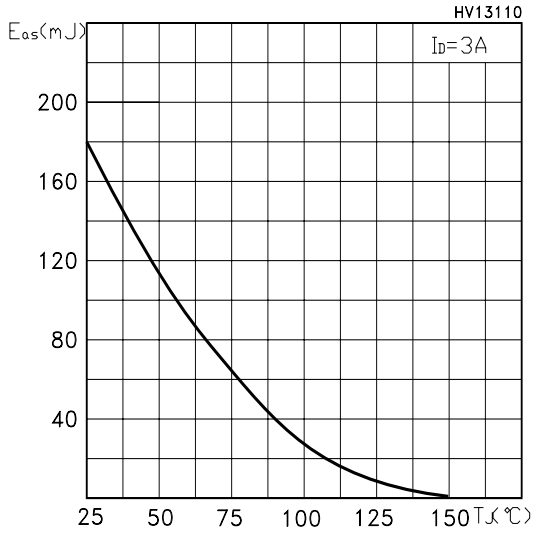

Fig. 1: Unclamped Inductive Load Test Circuit



Fig. 2: Unclamped Inductive Waveform



Fig. 3: Switching Times Test Circuit For Resistive Load



Fig. 4: Gate Charge test Circuit



Fig. 5: Test Circuit For Inductive Load Switching And Diode Recovery Times



TO-220 MECHANICAL DATA

| DIM. | mm | | | inch | | |
|------|-------|------|-------|-------|-------|-------|
| | MIN. | TYP. | MAX. | MIN. | TYP. | MAX. |
| A | 4.40 | | 4.60 | 0.173 | | 0.181 |
| C | 1.23 | | 1.32 | 0.048 | | 0.051 |
| D | 2.40 | | 2.72 | 0.094 | | 0.107 |
| D1 | | 1.27 | | | 0.050 | |
| E | 0.49 | | 0.70 | 0.019 | | 0.027 |
| F | 0.61 | | 0.88 | 0.024 | | 0.034 |
| F1 | 1.14 | | 1.70 | 0.044 | | 0.067 |
| F2 | 1.14 | | 1.70 | 0.044 | | 0.067 |
| G | 4.95 | | 5.15 | 0.194 | | 0.203 |
| G1 | 2.4 | | 2.7 | 0.094 | | 0.106 |
| H2 | 10.0 | | 10.40 | 0.393 | | 0.409 |
| L2 | | 16.4 | | | 0.645 | |
| L4 | 13.0 | | 14.0 | 0.511 | | 0.551 |
| L5 | 2.65 | | 2.95 | 0.104 | | 0.116 |
| L6 | 15.25 | | 15.75 | 0.600 | | 0.620 |
| L7 | 6.2 | | 6.6 | 0.244 | | 0.260 |
| L9 | 3.5 | | 3.93 | 0.137 | | 0.154 |
| DIA. | 3.75 | | 3.85 | 0.147 | | 0.151 |



TO-220FP MECHANICAL DATA

| DIM. | mm. | | | inch | | |
|------|------|-----|------|-------|-------|-------|
| | MIN. | TYP | MAX. | MIN. | TYP. | MAX. |
| A | 4.4 | | 4.6 | 0.173 | | 0.181 |
| B | 2.5 | | 2.7 | 0.098 | | 0.106 |
| D | 2.5 | | 2.75 | 0.098 | | 0.108 |
| E | 0.45 | | 0.7 | 0.017 | | 0.027 |
| F | 0.75 | | 1 | 0.030 | | 0.039 |
| F1 | 1.15 | | 1.5 | 0.045 | | 0.067 |
| F2 | 1.15 | | 1.5 | 0.045 | | 0.067 |
| G | 4.95 | | 5.2 | 0.195 | | 0.204 |
| G1 | 2.4 | | 2.7 | 0.094 | | 0.106 |
| H | 10 | | 10.4 | 0.393 | | 0.409 |
| L2 | | 16 | | | 0.630 | |
| L3 | 28.6 | | 30.6 | 1.126 | | 1.204 |
| L4 | 9.8 | | 10.6 | .0385 | | 0.417 |
| L5 | 2.9 | | 3.6 | 0.114 | | 0.141 |
| L6 | 15.9 | | 16.4 | 0.626 | | 0.645 |
| L7 | 9 | | 9.3 | 0.354 | | 0.366 |
| Ø | 3 | | 3.2 | 0.118 | | 0.126 |



TO-252 (DPAK) MECHANICAL DATA

| DIM. | mm | | | inch | | |
|------|------|------|-------|-------|-------|-------|
| | MIN. | TYP. | MAX. | MIN. | TYP. | MAX. |
| A | 2.20 | | 2.40 | 0.087 | | 0.094 |
| A1 | 0.90 | | 1.10 | 0.035 | | 0.043 |
| A2 | 0.03 | | 0.23 | 0.001 | | 0.009 |
| B | 0.64 | | 0.90 | 0.025 | | 0.035 |
| B2 | 5.20 | | 5.40 | 0.204 | | 0.213 |
| C | 0.45 | | 0.60 | 0.018 | | 0.024 |
| C2 | 0.48 | | 0.60 | 0.019 | | 0.024 |
| D | 6.00 | | 6.20 | 0.236 | | 0.244 |
| E | 6.40 | | 6.60 | 0.252 | | 0.260 |
| G | 4.40 | | 4.60 | 0.173 | | 0.181 |
| H | 9.35 | | 10.10 | 0.368 | | 0.398 |
| L2 | | 0.8 | | | 0.031 | |
| L4 | 0.60 | | 1.00 | 0.024 | | 0.039 |
| V2 | 0° | | 8° | 0° | | 0° |

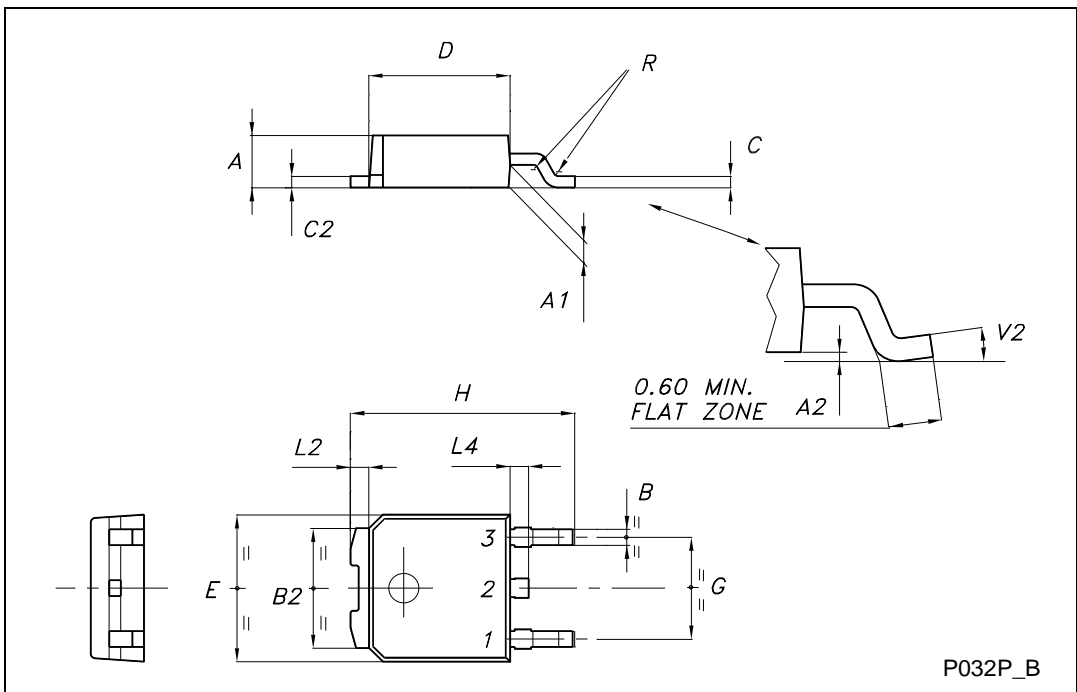

TO-251 (IPAK) MECHANICAL DATA

| DIM. | mm | | | inch | | |
|------|------|------|------|-------|-------|-------|
| | MIN. | TYP. | MAX. | MIN. | TYP. | MAX. |
| A | 2.2 | | 2.4 | 0.086 | | 0.094 |
| A1 | 0.9 | | 1.1 | 0.035 | | 0.043 |
| A3 | 0.7 | | 1.3 | 0.027 | | 0.051 |
| B | 0.64 | | 0.9 | 0.025 | | 0.031 |
| B2 | 5.2 | | 5.4 | 0.204 | | 0.212 |
| B3 | | | 0.85 | | | 0.033 |
| B5 | | 0.3 | | | 0.012 | |
| B6 | | | 0.95 | | | 0.037 |
| C | 0.45 | | 0.6 | 0.017 | | 0.023 |
| C2 | 0.48 | | 0.6 | 0.019 | | 0.023 |
| D | 6 | | 6.2 | 0.236 | | 0.244 |
| E | 6.4 | | 6.6 | 0.252 | | 0.260 |
| G | 4.4 | | 4.6 | 0.173 | | 0.181 |
| H | 15.9 | | 16.3 | 0.626 | | 0.641 |
| L | 9 | | 9.4 | 0.354 | | 0.370 |
| L1 | 0.8 | | 1.2 | 0.031 | | 0.047 |
| L2 | | 0.8 | 1 | | 0.031 | 0.039 |



DPAK FOOTPRINT



TUBE SHIPMENT (no suffix)*



TAPE AND REEL SHIPMENT (suffix "T4")*

40 mm min. Access hole at slot location

Full radius

Tape slot in core for tape start 2.5mm min. width

REEL MECHANICAL DATA

| DIM. | mm | | inch | |
|------|------|------|-------|--------|
| | MIN. | MAX. | MIN. | MAX. |
| A | | 330 | | 12.992 |
| B | 1.5 | | 0.059 | |
| C | 12.8 | 13.2 | 0.504 | 0.520 |
| D | 20.2 | | 0.795 | |
| G | 16.4 | 18.4 | 0.645 | 0.724 |
| N | 50 | | 1.968 | |
| T | | 22.4 | | 0.881 |

| | |
|-----------------|-----------------|
| BASE QTY | BULK QTY |
| 2500 | 2500 |

TAPE MECHANICAL DATA

| DIM. | mm | | inch | |
|------|------|------|-------|-------|
| | MIN. | MAX. | MIN. | MAX. |
| A0 | 6.8 | 7 | 0.267 | 0.275 |
| B0 | 10.4 | 10.6 | 0.409 | 0.417 |
| B1 | | 12.1 | | 0.476 |
| D | 1.5 | 1.6 | 0.059 | 0.063 |
| D1 | 1.5 | | 0.059 | |
| E | 1.65 | 1.85 | 0.065 | 0.073 |
| F | 7.4 | 7.6 | 0.291 | 0.299 |
| K0 | 2.55 | 2.75 | 0.100 | 0.108 |
| P0 | 3.9 | 4.1 | 0.153 | 0.161 |
| P1 | 7.9 | 8.1 | 0.311 | 0.319 |
| P2 | 1.9 | 2.1 | 0.075 | 0.082 |
| R | 40 | | 1.574 | |
| W | 15.7 | 16.3 | 0.618 | 0.641 |

TOP COVER TAPE

10 pitches cumulative tolerance on tape +/- 0.2 mm

Center line of cavity

User Direction of Feed

FEED DIRECTION

Bending radius R min.

For machine ref. only including draft and radii concentric around B0

* on sales type



Information furnished is believed to be accurate and reliable. However, STMicroelectronics assumes no responsibility for the consequences of use of such information nor for any infringement of patents or other rights of third parties which may result from its use. No license is granted by implication or otherwise under any patent or patent rights of STMicroelectronics. Specifications mentioned in this publication are subject to change without notice. This publication supersedes and replaces all information previously supplied. STMicroelectronics products are not authorized for use as critical components in life support devices or systems without express written approval of STMicroelectronics.

© The ST logo is a registered trademark of STMicroelectronics

© 2002 STMicroelectronics - Printed in Italy - All Rights Reserved
STMicroelectronics GROUP OF COMPANIES

Australia - Brazil - Canada - China - Finland - France - Germany - Hong Kong - India - Israel - Italy - Japan - Malaysia - Malta - Morocco
Singapore - Spain - Sweden - Switzerland - United Kingdom - United States.

© <http://www.st.com>